



JAGUAR

Born to perform



X-TYPE SPORT

Shown here in Ultraviolet paint, the Sport displays its unique styling features: body coloured grille surround and bumper blades, with a black finish to the window surrounds. Silver finish roof rails are optional on all X-TYPE Estate models.

A CAR OF MANY FACETS

X-TYPE ESTATE INTERIORS

The X-TYPE Estate accommodates the flexibility of modern lifestyles, without sacrificing the traditional Jaguar qualities of painstaking craftsmanship and superior comfort. So you can enjoy an interior with innovative driver control and safety systems technology, whilst appreciating the finely stitched cloth or leather upholstery and rich wood veneers.

The X-TYPE Estate range is fitted with a tailgate window that opens independently for extra convenience and rear seats that are split 70/30 to fold separately. Folding them both down creates a load space that is the largest in its class, without the need to remove the rear headrests. At all times your comfort is assured, with air conditioning, electric height adjustment for the driver's seat and an intrusion sensing security system, all as standard features.

Car shown: X-TYPE SE Quartz paint. Optional 18" Melbourne alloy wheels and rear parking assist.





The rear seats can be folded separately or together, giving you up to 1,415 cubic litres of carrying capacity, the largest in its class. The large load space and low sill lets you load and carry even bulky objects with surprising ease.

The detachable rear tonneau cover, also includes an optional vertical net (standard on SE models) that helps to keep your luggage in place and protect your passengers. A concealed, unlockable storage compartment offers quick and easy access to spare tyres and safety equipment.



X-TYPE CLASSIC

In Warm Charcoal cloth with Bronze stained Sapele veneer.

MEMORY DRIVER'S SEAT AND DOOR MIRRORS

The optional 10-way electrically adjustable front power seats feature three-position memory settings for the driver. The angle of the door mirrors automatically adjusts with the seat.

REAR CENTRE ARMREST WITH TWIN CUPHOLDERS

The rear centre armrest is fitted with twin cupholders.

X-TYPE SE

Shown here with Champagne leather upholstery with Bronze stained Sapele veneer. The load space includes four chromed luggage tie-down hooks, two lights and chromed handles to the detachable side storage compartment doors.









ALCANTARA® SPORT SEATS

Trimmed half in black leather, half in Alcantara®, the optional Sport seats have powered 8-way adjustment for the driver and 2-way for the front passenger.

SPORTS LEATHER TRIM

Appropriately, the Sport features a performance themed perforated leather steering wheel and matching gearknob for its short throw gearshift.

CARBON FIBRE

Emphasising the sporting theme, a genuine Carbon Fibre fascia is optional for Sport interiors.

X-TYPE SPORT

The Sport interior showing optional Sport seats, specially contoured and trimmed in Warm Charcoal Alcantara®.

ENERGY AND INTELLIGENCE

X-TYPE ESTATE TECHNOLOGY

Jaguar has always used technology to put its cars at the forefront of their class. The X-TYPE Estate's modern innovations include Traction[®] four-wheel-drive, standard on 2.5 litre and 3 litre petrol models, or electronic traction control, fitted to 2 litre diesel models. Plus the options of Dynamic Stability Control with Emergency Brake Assist and headlights which turn on automatically when light levels fall.

Effective passive safety including an exceptionally robust body is an integral and reassuring part of the X-TYPE's design. The X-TYPE Estate is also equipped with advanced active safety systems, yet their technology does not diminish the driving experience. Instead it enhances it by ensuring you feel naturally and comfortably in control. So you can appreciate the quality for which Jaguar cars have become legendary: transforming an ordinary road into an exhilarating drive.





TRACTION[®]

Traction[®] four-wheel-drive, standard on 2.5 litre and 3 litre petrol models, contributes to active safety in rain, sleet, snow and ice, and proves its worth through fast or tight corners on dry roads, complementing the X-TYPE Estate's natural balance and stability.

ELECTRONIC TRACTION CONTROL

Fitted to the 2 litre diesel X-TYPE Estate, traction control uses the ABS sensors to detect wheel spin and restrict power to either of the front wheels until full adhesion is regained.

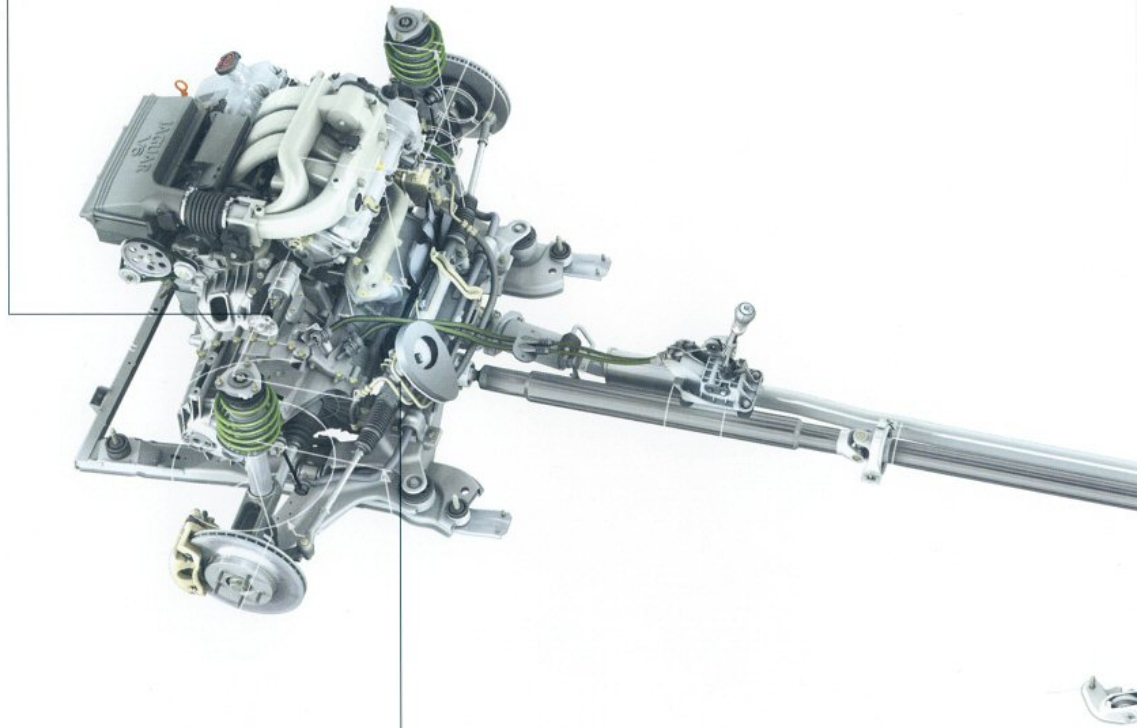

VARIABLE RATIO POWER ASSISTED STEERING

A variable ratio gives you a slower ratio around the straight-ahead position, improving high speed and on-centre stability, balanced with greater agility and fewer turns of the steering wheel from lock to lock when parking.

DSC

Optional Dynamic Stability Control gives you an extra feeling of confidence in your X-TYPE. If it detects that the car is not turning in accordance with your steering input, it reduces engine power and gently applies the brakes so that stability and full control are restored.

X-TYPE
ESTATE



JAGUAR

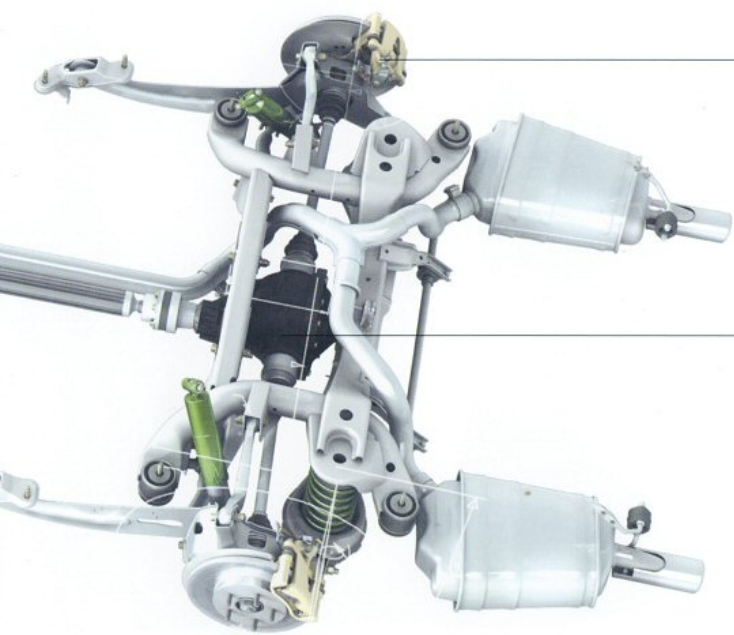

EBD

Electronic Brake force Distribution regulates the effort between the front and back brakes, taking the car's load and speed into account, to optimise stopping performance and vehicle stability.

ABS

The four-channel Anti-lock Braking System ensures that the wheels don't lock up during emergency braking even on wet, slippery surfaces, so it can help you retain steering control to avoid obstacles.

FOUR-WHEEL-DRIVE

Traction[®], standard on 2.5 litre and 3 litre petrol models, normally distributes power in a 40%/60% front/rear split. But the moment it senses a difference in grip between the front and rear wheels, it redirects power to achieve optimum traction.



What gives a Jaguar chassis its unique, almost legendary quality is the combination of rolling comfort (isolation from the surface texture of the road) together with precise responsive handling and excellent communication with the driver, particularly through the steering.

This produces a car which is both very relaxing and comfortable to drive, but also feels highly connected and therefore very rewarding. Then we introduce the additional technology of our active safety systems - for example, Traction[®], which has a 40%/60% front/rear power split to give the optimum balance between handling response, stability and traction, and DSC which improves controllability in extreme circumstances and on low friction surfaces.

DAVID WAIDE
Chief Engineer, Chassis Group

PASSIVE SAFETY

The X-TYPE Estate's passive safety system includes sophisticated occupancy sensing and dual-stage front airbags as standard equipment; just part of an uncompromising approach to your safety.

DRIVER AND PASSENGER AIRBAGS

The X-TYPE has advanced dual-stage front airbags which adapt to the force of the impact, helping to reduce the risk of head injuries, especially for smaller front-seat occupants. Deployment is determined by sophisticated occupancy sensors that monitor the position of the driver's seat, the weight of the front passenger and whether seat belts are being used.

CRUMPLE ZONES

These front and rear zones are specially designed to absorb and deflect the force of an impact, dissipating its energy so that the rigid passenger safety cell can still provide the best possible protection.

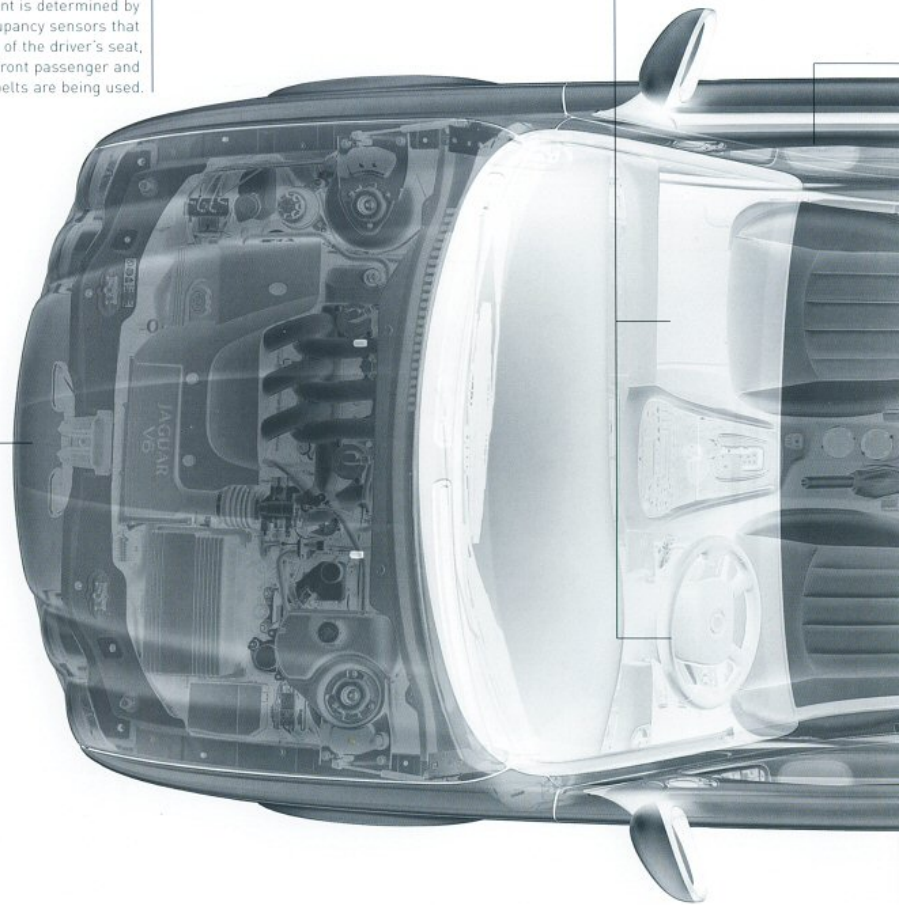

FRONT BELT PRE-TENSIONERS

The X-TYPE Estate's front seatbelts have pre-tensioners that react in milliseconds to hold the occupant safely in position.

SIDE IMPACT PROTECTION

To complement its side and curtain airbags, the X-TYPE Estate has reinforced anti-intrusion bars in all four doors, to resist the force of a collision.

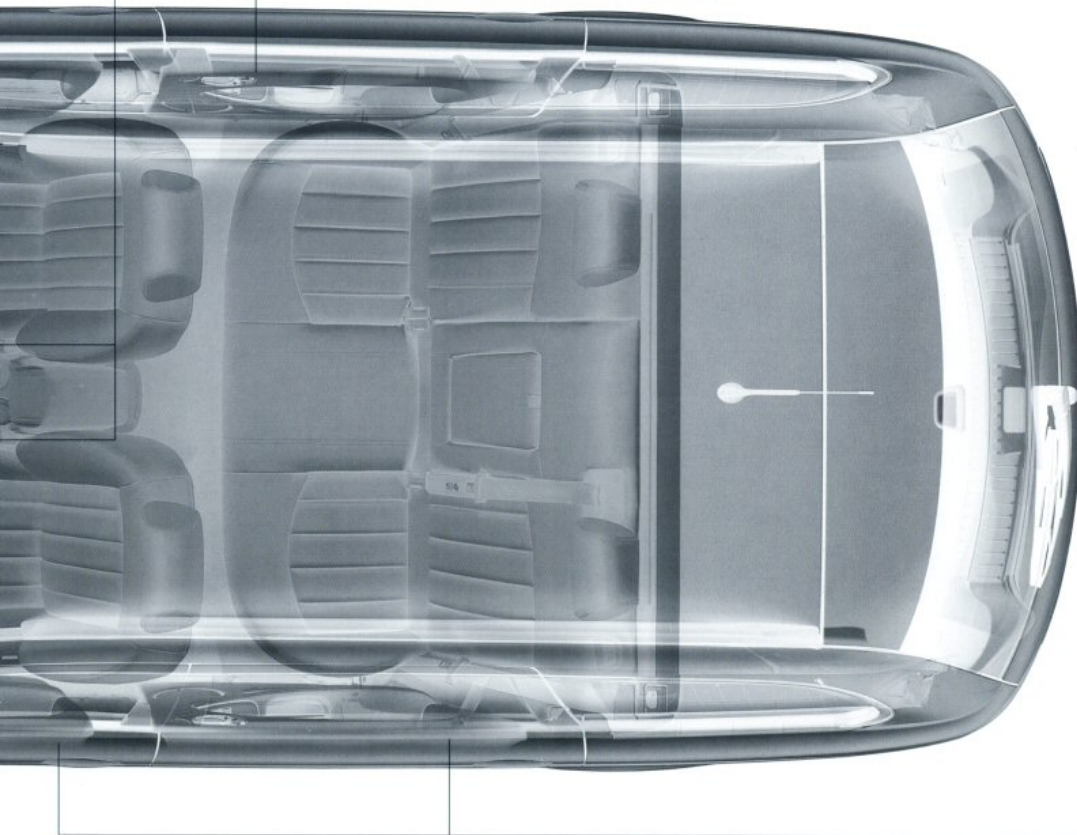

We spend upwards of 175,000 hours of computer processing time assessing safety performance on a new vehicle programme. Multiple analysis runs are conducted from concept through to vehicle sign-off, checking performance through multiple crash scenarios. The analysis enables us to understand in detail and optimise the interaction of the structure, powertrain, chassis, trim and restraint systems. The entire system works as one to offer maximum protection to the occupants.

We still crash cars as final confirmation of safety performance. Even with the significant use of analysis tools we will complete approximately 160 component and system tests and sacrifice around 80 cars to confirm what the computers have predicted.

MARK JOHNSON
Assurance Manager, Vehicle Safety

SIDE AND CURTAIN AIRBAGS

The moment a side impact occurs, side curtain airbags drop down from above the doors to cover the front and side windows, shielding the heads and torsos of front and rear occupants. At the same time, side airbags deploy from the outer side bolsters of the front seats to help protect the driver's or passenger's rib cage.



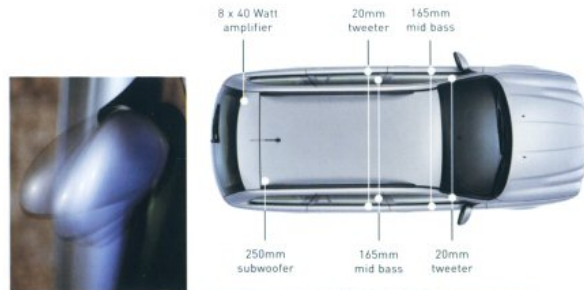

POWER FOLDBACK MIRRORS

Ideal for squeezing through narrow gaps and to prevent damage, the optional power foldback mirrors operate at the touch of a button.

PARKING ASSIST

The optional parking sensors detect any obstacles within their range (see graphic), warning you with a series of beeps as you manoeuvre; the closer together the beeps, the nearer the car is to the object.

JAGUAR ALPINE PREMIUM SOUND SYSTEM

The optional Jaguar Alpine Premium Sound System brings you 9 unique Dual Direct Drive speakers that are acoustically tailored to the X-TYPE's interior. DSP technology also allows you to tune sound output to the number of people in the car and where they're sitting. This means that everyone, not only the driver, will enjoy premium-quality audio.

MULTIMEDIA DISPLAY SYSTEM

The lightest touch on the 7" LCD screen of this optional system selects the function you want from automatic climate control, audio and (where fitted), satellite navigation, television and telephone.

SATELLITE NAVIGATION AND JAGUARVOICE

The optional DVD-based satellite navigation system can be controlled by JaguarVoice (also optional). Simply press a button on the steering wheel and your spoken commands will also control the main functions of the automatic climate control, audio and (where fitted), television and telephone.





Use of the V6 in the X-TYPE brings particular benefits and not just in terms of its smoothness and performance. The V6 is a short, compact, stiff package, so its lightness contributes to good handling. It also helps us achieve excellent crush performance; because it's compact, it's less likely to compromise the passenger safety cell in a frontal impact: a valuable safety feature.

The new diesel engine produces lots of low rpm torque and that's a vital feature; precisely the performance characteristics you want for usable, real-world acceleration and fast and relaxed cruising. It has real Jaguar DNA, so the X-TYPE Diesel definitely drives like a Jaguar.

TONY CARTWRIGHT
Chief Engineer, Powertrain

V6 POWER

The heart of any performance car is its engine. The X-TYPE Estate petrol engine is a superb four camshaft, 24 valve V6 with a high torque output at low to medium engine speeds for easier overtaking and relaxed, quiet cruising. The X-TYPE 2 litre diesel engine delivers genuine Jaguar performance, using short nozzle injectors and an innovative transient overboost to produce the highest torque output of any X-TYPE engine.

TECHNICAL SPECIFICATIONS

	2.5 LITRE V6 TRACTION ⁽⁴⁾ (four-wheel-drive)		3 LITRE V6 TRACTION ⁽⁴⁾ (four-wheel-drive)		2 LITRE DIESEL
ENGINE					
Cylinders/valves per cylinder	6/4		6/4		4/4
Bore/stroke - mm	81.6/79.5		89.0/79.5		86/86
Capacity - cc	2,495		2,967		1,998
Maximum power - DIN bhp [kW]	194 [145]		231 [172]		128 [96]
EEC PS [kW] @ rev/min	196 [144] @ 6,800 rpm		231 [169] @ 6,800 rpm		130 [96] @ 3,800 rpm
Maximum torque - DIN lb.ft. [Nm]	180 [244]		209 [284]		244 [331]
EEC lb.ft. [Nm] @ rev/min	178 [241] @ 3,000 rpm		206 [279] @ 3,000 rpm		243 [330] @ 1,800 rpm
Compression ratio :1	10.3		10.5		18.2
Transmission	5-speed manual	5-speed automatic	5-speed manual	5-speed automatic	5-speed manual
PERFORMANCE (1)					
Acceleration 0-60 mph [0-100 km/h] - sec	8.2 [8.6]	8.8 [9.2]	6.9 [7.3]	7.3 [7.8]	9.8 [10.2]
Top speed - mph [km/h]	138 [222]	135 [217]	144 [232]	141 [227]	123 [198]
FUEL ECONOMY					
Urban - mpg [l/100km]	20.5 [13.8]	18.6 [15.2]	19.0 [14.9]	18.5 [15.2]	36.7 [7.7]
Extra urban - mpg [l/100km]	38.5 [7.3]	36.9 [7.7]	36.4 [7.8]	35.9 [7.9]	60.4 [4.7]
Combined - mpg [l/100km]	29.0 [9.7]	27.1 [10.4]	27.3 [10.4]	26.6 [10.6]	48.7 [5.8]
Carbon dioxide emissions - g/km	239	249	249	254	154
Tank capacity - gals [Ltr] approx. (incl. 5 Ltr reserve)	13.5 [61.5]	13.5 [61.5]	13.5 [61.5]	13.5 [61.5]	13.5 [61.5]
WEIGHT (2) / DIMENSIONS					
Kerb weight - lb [kg]	3,539 [1,605]	3,605 [1,635]	3,539 [1,605]	3,605 [1,635]	3,473 [1,575]
Gross vehicle weight - lb [kg]	4,586 [2,080]	4,675 [2,120]	4,586 [2,080]	4,675 [2,120]	4,520 [2,050]
Permitted roof load - lb [kg]	165 [75]		165 [75]		165 [75]
Permitted trailer load, unbraked - lb [kg] (3)	1,654 [750]		1,654 [750]		1,654 [750]
Permitted trailer load, braked - lb [kg] (3)	3,307 [1,500]		3,307 [1,500]		3,307 [1,500]
Permitted towbar download - lb [kg]	132 [60]		132 [60]		132 [60]
Turning circle (kerb to kerb) - ft. in. [m]	35' 7" [10.84]		35' 7" [10.84]		35' 7" [10.84]
Luggage capacity: rear seats up, to luggage blind - cu. ft. [litres - VDA]	16 [445]		16 [445]		16 [445]
Luggage capacity: maximum with rear seats forward - cu. ft. [litres - VDA]	50 [1,415]		50 [1,415]		50 [1,415]

(1) The fuel economy figures were obtained in tests carried out in line with the Passenger Car Fuel Consumption Amendment Order 1996 (Reflecting EU Directive 1999/100 EEC fuel consumption test cycle). These figures were correct at the time of going to press.

(2) Please consult your dealer for details of changes associated with option fitment. Kerb weights reflect vehicles to standard specifications. Optional extras increase weight.

(3) Up to maximum 12% gradient.

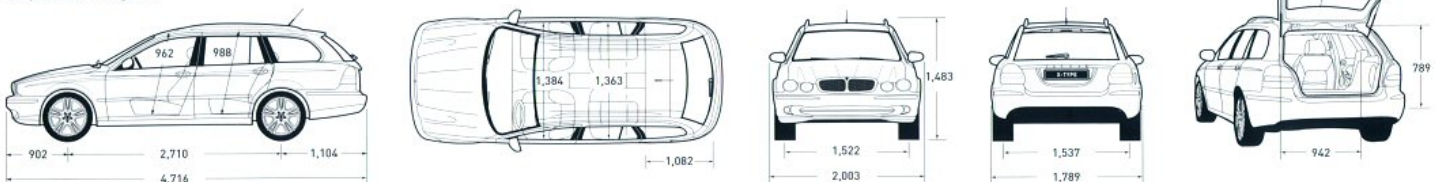

Dimensions shown in mm.

NOTE: The dimension details refer to a nominal car but may vary marginally from car to car due to design and production tolerances. The nominal condition has been used wherever possible. Please consult your dealer for details of changes associated with option fitment.

KEY STANDARD EQUIPMENT

	Classic	SE in addition to Classic	Sport in addition to Classic
TRANSMISSION, SUSPENSION, BRAKES	<ul style="list-style-type: none"> 5-speed manual transmission Jaguar Traction[®] (full-time, four-wheel-drive) Touring suspension Traction control (front-wheel-drive) 	<ul style="list-style-type: none"> Cruise control 	<ul style="list-style-type: none"> Sport suspension
EXTERIOR FEATURES	<ul style="list-style-type: none"> Black roof rails Body coloured bumper blades and de-chromed window surrounds Exterior mirrors - power adjustable, heated Front fog lights 	<ul style="list-style-type: none"> Chrome finish bumper blades, window surrounds and tipped grille vanes 	<ul style="list-style-type: none"> Body colour grille surround and bootlid finisher Rear spoiler
WHEELS	<ul style="list-style-type: none"> Caicos forged alloy 16" 	<ul style="list-style-type: none"> Cayman forged alloy 17" (2.5 litre/3 litre) Tobago forged alloy 16" (2 litre) 	<ul style="list-style-type: none"> Andros forged alloy 17" (2 litre) Aruba forged alloy 18" (2.5 litre/3 litre)
INTERIOR THEMES AND TRIM	<ul style="list-style-type: none"> Colour keyed upper facia and door top rolls, Bronze stained Sapele veneer facia 	<ul style="list-style-type: none"> Door inserts to match facia Four spoke leather rimmed steering wheel with audio, telephone (where fitted), voice and cruise controls Gearknob - leather 	<ul style="list-style-type: none"> Four spoke perforated leather rimmed sport style steering wheel with audio, telephone (where fitted), voice and cruise controls Gearknob - Sport perforated leather Warm Charcoal upper facia and door top rolls with Grey stained Birds Eye Maple veneer facia
SEATING	<ul style="list-style-type: none"> Cloth upholstery Fold down rear seat (split 70/30) Manually adjustable front seats with power drivers seat height adjust 	<ul style="list-style-type: none"> 8-way driver and 2-way passenger power adjustable front seats Leather upholstery 	<ul style="list-style-type: none"> 4-way driver and 2-way passenger power adjustable front seats Sport cloth/leather upholstery
INTERIOR FEATURES	<ul style="list-style-type: none"> Electric front windows with one-touch open and close and anti-trap Electric rear windows with one-touch open and close and anti-trap (2.5 litre) Front double cupholder Hidden stowage under load floor with 12V power supply Luggage cover Manual air conditioning with pollen filter (2 litre) Rear armrest with 2 cupholders Sunvisors illuminated with vanity mirror, driver and front passenger 	<ul style="list-style-type: none"> Automatic climate control with pollen filter Cargo compartment net Centre armrest-Front, sliding Electric rear windows with one-touch open and close and anti-trap Trip computer with message centre 	<ul style="list-style-type: none"> Automatic climate control with pollen filter (2.5 litre/3 litre) Electric rear windows with one-touch open and close and anti-trap (2.5 litre/3 litre)
AUDIO	<ul style="list-style-type: none"> Chrome speaker surrounds Jaguar Alpine Sound System with 6 speakers, AM/FM radio/single slot CD featuring EON, RDS, PTY, TA and automatic volume control 		
SAFETY	<ul style="list-style-type: none"> Airbags, front and side, driver and front passenger Anti-lock Braking System Curtain airbags front and rear High-level stop light Occupancy sensing system 		
SECURITY	<ul style="list-style-type: none"> Remote central double locking with 2 stage unlock and perimeter sensing alarm 		
KEY OPTIONS	<ul style="list-style-type: none"> CD autochanger Dynamic Stability Control (DSC) with Emergency Brake Assist Front and rear parking assist Jaguar Alpine Premium Sound System JaguarVoice Memory function on drivers seat and exterior door mirrors (with 10-way seats) Navigation system with DVD mapping and 7" Touch-screen Rain sensing windscreen wipers (part of Auto Clear View pack) TV with Teletext (whilst stationary) 		

* For a full list of standard and optional equipment please refer to the Specification and Price Guide or jaguar.co.uk

EXTERIOR COLOUR GUIDE



WHITE ONYX fitted with 16" Caicos alloy wheels



ZIRCON* fitted with 17" Cayman alloy wheels



PLATINUM* fitted with 17" Andros alloy wheels



ULTRAVIOLET* fitted with 18" Aruba alloy wheels



QUARTZ* fitted with 18" Melbourne alloy wheels



PACIFIC* fitted with 16" Tobago alloy wheels

* Metallic paint.

The colours are intended to serve primarily as a guide and, while they approximate to the actual shades, they should not be utilised for paint matching or for any other purpose where complete accuracy is essential. Jaguar Cars Ltd., reserve the right to alter or withdraw any colour finish or trim without notice.



CONTENTS

4 JAGUAR: A UNIQUE APPEAL 6 PERFORMANCE IN A NEW SHAPE: THE X-TYPE ESTATE RANGE
10 A CAR OF MANY FACETS: X-TYPE ESTATE INTERIORS 16 ENERGY AND INTELLIGENCE: X-TYPE ESTATE TECHNOLOGY
26 TECHNICAL SPECIFICATIONS AND KEY STANDARD EQUIPMENT 28 EXTERIOR COLOURS AND WHEELS
30 INTERIOR CHOICES 32 VEHICLE PERSONALISATION 33 SERVICE, ASSURANCE AND PEACE OF MIND
34 THE JAGUAR OWNERSHIP EXPERIENCE



JAGUAR RACING GREEN* fitted with 18" Aruba alloy wheels



BRITISH RACING GREEN fitted with 16" Tobago alloy wheels



EBONY fitted with 17" Cayman alloy wheels



SALSA fitted with 18" Melbourne alloy wheels



RADIANCE* fitted with 16" Caicos alloy wheels



TOPAZ* fitted with 17" Andros alloy wheels

INTERIOR CHOICES



CLOTH (Classic)

WARM CHARCOAL



LEATHER (Classic/SE)

CHAMPAGNE



SPORT CLOTH / LEATHER

CHAMPAGNE



SPORT LEATHER

STONE



SPORT LEATHER / ALCANTARA*

WARM CHARCOAL



BRONZE STAINED SAPELE



GREY STAINED BIRDS EYE MAPLE



PIANO BLACK



CARBON FIBRE

*For full details of available interior trim combinations and extra costs for upfitting materials, where applicable, please consult your dealer and current price list.

TRIM COMBINATIONS

	Champagne Stone	Warm Charcoal	Bronze stained Sapele	Grey stained Birds Eye Maple	Piano Black	Carbon Fibre
Cloth [Classic]	•	•	•	•	•	•
Leather [Classic]	•	•	•	•	•	•
Leather [SE]	•	•	•	•	•	•
Sport Cloth/Leather	•	•	•	•	•	•
Sport Leather	•	•	•	•	•	•
Sport Leather/Alcantara*	•	•	•	•	•	•

SEAT COLOURS

VENEERS

VEHICLE PERSONALISATION

Create a Jaguar as individual as you are, with personal touches that will make your Jaguar X-TYPE Estate even more convenient and enjoyable.

Keep in touch with the sophisticated Jaguar hands-free telephone and enjoy hours of listening with the 6-disc CD-Autochanger.

Enhance its good looks with a choice of stylish alloy wheels, sporty black mesh radiator grille or a wood/leather steering wheel. Add extra carrying capacity with our range of customised roof carrying systems, specially developed towing equipment and storage accessories for the X-TYPE Estate's interior and load space.

For more details, ask your dealer or see the full range on jaguar.co.uk.



DETACHABLE TOW BAR

Engineered specifically for the X-TYPE Estate, the tow bar has a detachable ball hitch, easily removed without the use of tools when not in use.



A roof box adds useful extra capacity to the X-TYPE Estate's already extensive load space. The car featured here is an X-TYPE Estate SE in Platinum paint with 18" Aruba alloy wheels.



LUGGAGE PARTITION

Separates the cabin from the load space, protecting you from shifting luggage. A vertical divider is also available which for example can keep your pets and your luggage or shopping separate.



INTERIOR PROTECTION

A range of durable and waterproof luggage compartment liners and utility mats are available to protect the load space trim and the carpets of your vehicle.

SERVICE, ASSURANCE AND PEACE OF MIND

SERVICE AND ASSURANCE

Jaguar Service and Assurance programmes include Standard Price Servicing, so you know the exact cost before servicing commences. Total Tyre Care, from checks on tyre tread depth and pressure, to competitively priced replacement tyres and wheel alignment. Plus Seasonal Health Checks, to ensure your Jaguar is in peak condition all year round.

ONE STOP FOR ALL YOUR JAGUAR NEEDS

Only an official Jaguar dealer can give your car all the care and attention it deserves, with Jaguar trained technicians who have access to the full range of Jaguar approved parts and tools. So that any fitting or repair is carried out exactly the way Jaguar intended.

A comprehensive range of services is available to make your Jaguar ownership experience the very best, for lasting peace of mind.

JAGUAR ASSISTANCE

Jaguar Assistance is 24 hour Incident Management support, designed specifically to help Jaguar drivers in any motoring incident, from minor difficulties such as a puncture to immobilisation due to an accident.

In the UK, our Jaguar trained roadside assistance technicians will get your vehicle back on the road in the shortest possible time. If this is not possible, Jaguar Assistance will find you and your passengers an alternative means of reaching your destination. Travel benefits include car hire, vehicle redelivery and hotel accommodation in the UK. Jaguar European Emergency Assistance affords you similar cover should you be travelling in Continental Europe.

In addition, optional Extended Warranties extend the 3 year unlimited mileage warranty cover for a further 12, 24 or 36 months (years 4, 5 and 6). Each Extended Warranty gives you extensive cover and automatically includes Jaguar Assistance. Ask your dealer for further details.



THE JAGUAR OWNERSHIP EXPERIENCE

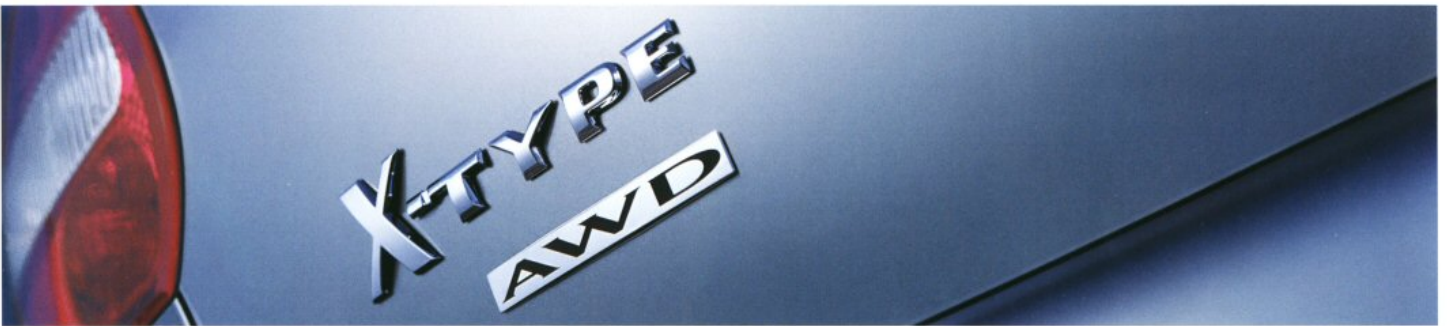

JAGUAR FINANCIAL SERVICES

Jaguar Financial Services offer a range of finance and insurance plans tailored to provide maximum choice and flexibility. You'll be as impressed with the finance as you are with the car. Your Jaguar dealer will match your personal or business requirements to the most appropriate finance plan, provide you with quotations and process your application.

COMPANY CAR OPT OUT

Because of the changes in company car Benefit in Kind taxation introduced in April 2002, many company fleet operators and company car drivers are considering their alternatives. Jaguar Financial Services and Jaguar Cars Limited have jointly developed a combination of Jaguar Privilege PCP, Jaguar Service Contract and Jaguar Insurance finance and insurance plans for business customers and private individuals who may have chosen to opt out of their company car scheme. Please contact your Jaguar dealer for further information.

WWW.JAGUAR.CO.UK

Your personal Jaguar journey may begin with a visit to jaguar.co.uk. The website includes helpful tools such as a dealer locator, specifications and price lists, the latest information on all the Jaguar models, information on clubs, and a fascinating look into the passion and legacy that infuse the Jaguar name.

JAGUAR MAGAZINE

In this unique owners' publication, you can read about exotic and exciting drives to take with your Jaguar, stories of other Jaguar owners and their experiences with their cars, highlights on Jaguar's activity in the exciting world of Formula One racing, and the finer things that go hand in hand with a luxury lifestyle.

OWNERSHIP

Your Jaguar comes with Total Care which incorporates a 3 year unlimited mileage Vehicle Warranty, together with a 3 year unlimited mileage Paint Surface Warranty and a 6 year unlimited mileage Corrosion (Perforation) Warranty.



IMPORTANT NOTICE

Jaguar Cars Limited is constantly seeking ways to improve the specification, design and production of its vehicles and alterations take place continually. Whilst every effort is made to produce up-to-date literature, this brochure should not be regarded as an infallible guide to current specifications, nor does it constitute an offer for the sale of any particular vehicle. Distributors and dealers are not agents of Jaguar Cars Limited by any express or implied undertaking or representation.

ENVIRONMENTAL NOTICE

Jaguar Cars Limited has a vision of being amongst the world's leading companies in demonstrating progress towards sustainability. We aim to do this by contributing to a better quality of life for communities affected by the design, manufacture, use and disposal of Jaguar cars. We believe that playing a supportive role in the communities in which we operate is a privilege, not an obligation. Corporate citizenship goes to the very heart of our company.

It is Jaguar's policy continually to improve its high environmental standards in all areas of business activity.

This brochure is produced using virgin wood fibre from sawmill residues, forest thinnings and sustainable forests. Pulp used are Elemental Chlorine Free.

Jaguar Cars Limited
Browns Lane Allestey
Coventry CV5 9DR

WWW.JAGUAR.CO.UK

Printed in England

JLM/10/02/19/04



JAGUAR
A UNIQUE APPEAL

The Jaguar name instils passion and anticipation around the world. It stands for design that is instantly recognised yet continuously evolving. It promises and delivers legendary levels of comfort and sporting, satisfying handling. It brings you the benefit of years of development through motor sport, with instant power that produces a sheer adrenaline thrill.

To own a Jaguar is to experience a unique spirit.
To drive a Jaguar is an ambition fulfilled.



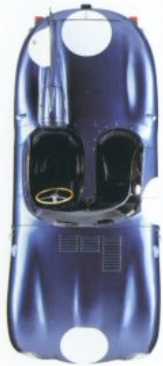

PERFORMANCE IN A NEW SHAPE

THE X-TYPE ESTATE RANGE

From any angle, it's undoubtedly a Jaguar, with a shape that communicates power, luxury and presence. Yet for the first time from Jaguar, this is a performance car that is also an estate.

The X-TYPE Estate opens up a world of possibilities. There are three distinct themes of styling and equipment: X-TYPE Classic, X-TYPE SE and X-TYPE Sport. With a choice of three engines: a 2 litre diesel, 2.5 litre and 3 litre petrol V6, including the Traction[®] four-wheel-drive system on 2.5 litre and 3 litre models. All cars are equipped with a five-speed manual gearbox and for the petrol models, there's the option of a five-speed electronic automatic transmission.

In addition, the X-TYPE Estate brings you more: a combination of versatility and the traditional Jaguar virtues that give every journey an even greater sense of reward and satisfaction.

Car shown: X-TYPE SE Quartz paint. Optional 18" Melbourne alloy wheels.





